











LETTI MATRIMONIALI normali e con contenitore

Q.tà	Descrizione	Immagine	Cod.
4	VITE TSP 8 x 55 + DADO		V
4	VITI 10 MA x 20 TE		VT
40	TBL 6 MA x 20 ZINC.		V
4	TBL 8 x 30 ZINC.		Vz
8	TBL 6MA X 60 SOLO LATO TESTATA SU MODELLI: EGO, PAPILLON, SNOW, TENDER, DREAM E CHIC		Vs
4	RONDELLA IN PLASTICA MM 5		Ro
12	PIEDE PANNELLO CONTENITORE		P
4	PIEDE LETTO		Pl
8	SQUADRA REGGIRETE PER SOSTEGNO RETE SU PEDIERA COMPLETA DI VITI PER FISSAGGIO		S
2	MECCANISMO CON PISTONI PER SOLLEVAMENTO RETE - 1SX / 1DX COMPLETO DI VITI PER FISSAGGIO SU GIROLETTO E RETE (SOLO PER CONTENITORE)		M5 M6
1	RETE ORTOPEDICA DOGHE IN LEGNO (SOLO PER CONTENITORE: COMPLETA DI FERMAMATERASSI IN METALLO E ALZARETE IN CORDA)		R

* in barrare la casella in caso di ferramenta mancante e inviare la pagina via fax al Numero 0733.579663

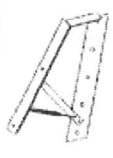
Completare questo modulo in caso di contestazione:

CLIENTE: _____

RIFERIMENTO: _____

NOTE: _____

Passo 1 di 9

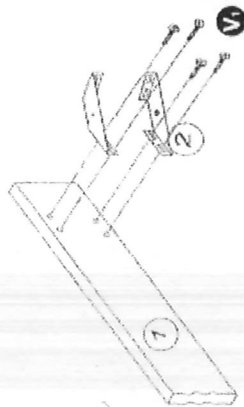

Passo 2 di 9

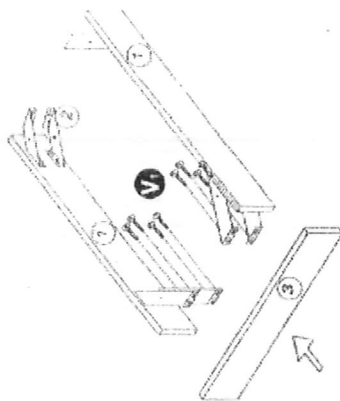

Passo 3 di 9

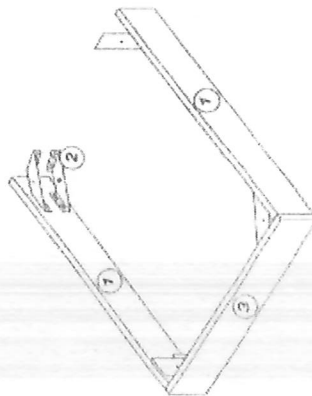

Passo 4 di 9

Fissare i piedi cilindrici alla staffa inferiore con la vite VT

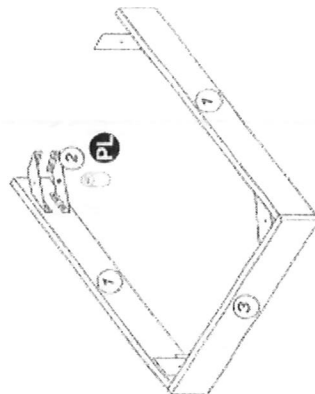

Passo 5 di 9

MONTAGGIO DEL RIVESTIMENTO:
Iniziare a montare il tessuto dalla pediera. Centrarlo bene sugli angoli facendo scorrere il velcro lungo i longoni.

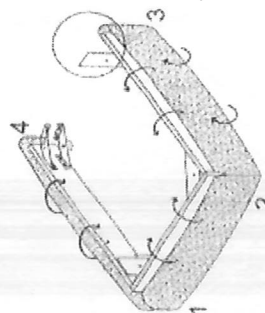

Passo 6 di 9

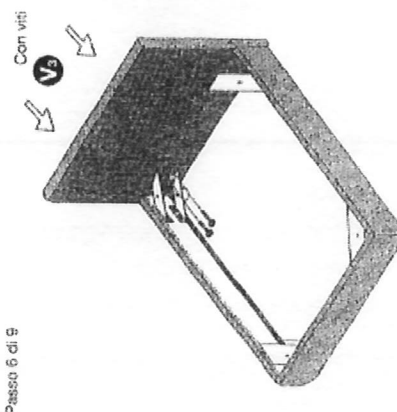

Passo 7 di 9

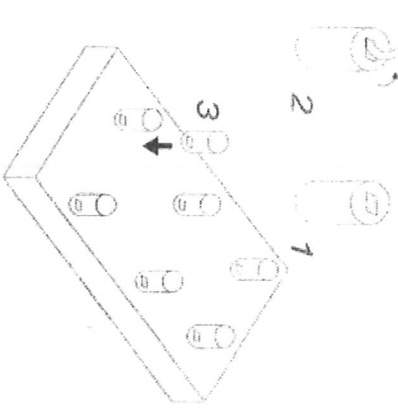

Passo 8 di 9

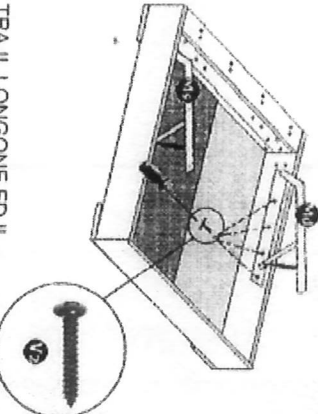

TRA IL LONGONE ED IL TRAPEZIO INSERIRE LA RONDELLA

Passo 9 di 9

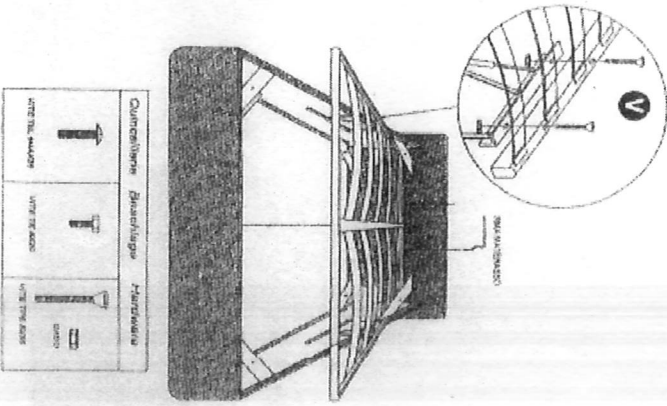

giessegi
INDUSTRIA MOBILI S.P.A.

Ufficio Tecnico

LINEA
CLASS
Cod. 7M 145

**Schema di Montaggio Letto
NORMALE E CON CONTENITORE**

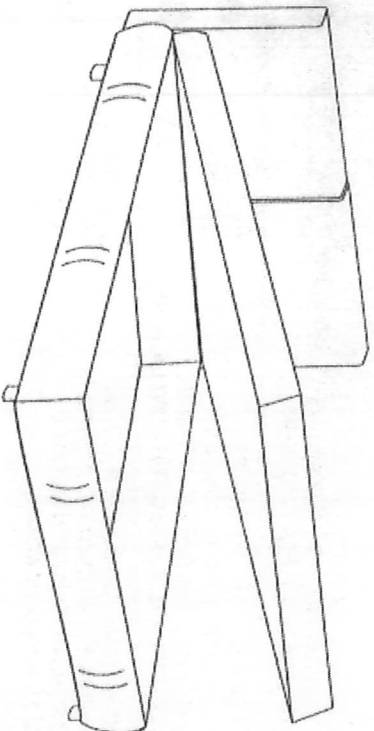

giessegi

Via Bramante, 39 - 62010 APPIGNANO (MC)
Tel. 0733.400811 - Fax 0733.57628
www.giessegi.it - info@giessegi.it